

# waykar

## Home Dehumidifier

Please read the manual carefully  
before using the unit

**PD1201B**

USER MANUAL



## FOR CUSTOMERS

Thank you for purchasing our dehumidifier.

**Waykar** wishes that our products and services can bring convenience to your work and life. We highly recommend that you keep the manual for reference if you encounter unexpected events using the unit.

Please read the manual carefully to ensure proper use of the dehumidifier. Our dehumidifiers are widely used in family bedrooms, bathrooms, basements, offices and storage rooms, etc.

The dehumidifiers from **Waykar** provide quick and efficient operation to reduce room's humidity and bring you a healthy and comfortable life.

## TO ACCESS CUSTOMER SUPPORT FASTER

If there is any problem of the product, please contact Waykar Customer Service at [support@waykar.com](mailto:support@waykar.com) with your Purchase Order ID to help you address the problem more effectively.

# BEFORE FIRST USE:

To prevent any internal damage, it is very important to keep refrigeration units (like this one) upright throughout their journey.

Please leave it standing upright and outside the box for **24 HOURS** before plugging it in.

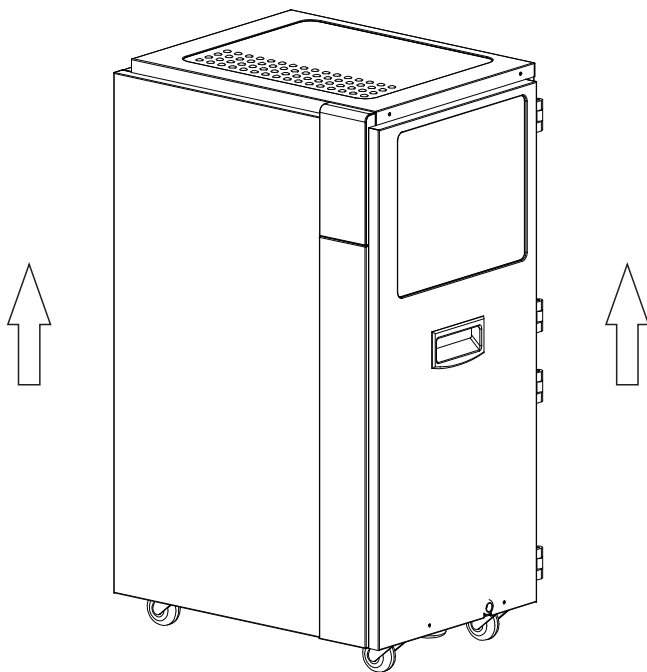

# CATALOG

Safety Instructions .....	01
Parts Description.....	03
Control Interface.....	04
Operation Instructions.....	05
Errors and Protection Code .....	07
Product Specifications.....	08
Safety Note and Maintenance Methods.....	09
Cleaning and Maintenance.....	11
Common Troubleshooting.....	12
Warranty and Contact Us .....	13

## Statement

The graphics and functions provided in this manual may not be the same as the actual product. Please always refer to the actual product.

The model of the machine on the manual is for reference only. Please check the corresponding content and operate the machine based on the actual product.

The right to interpret the relevant terms belongs to the company.

# SAFETY INSTRUCTIONS



## IMPORTANT NOTICE!

For your safety, please read the manual carefully and follow all the safety instructions below.

## Important Safety Instructions

- Please read the safety instructions in this manual carefully before installation, use and maintenance.
- Children should be supervised to ensure that they do not play with the appliance.
- To avoid risk of electric shock, do not operate this dehumidifier in an area that is likely to accumulate standing water. If this condition develops, disconnect the power supply before stepping into the water.
- Handle the packaging materials of the products in time, do not let the baby and children touch, avoid suffocation accidents.
- Before connecting the power supply, make sure that the power supply provides the same voltage and frequency required by the machine.
- Do not store or use combustible materials such as gasoline or other flammable vapors or liquids in the vicinity of this or any other appliance.
- Do not insert fingers or other objects into grilles or openings in the appliance.
- Do not operate the appliance below 41 Fahrenheit.
- **Special Note: When the display screen does not light up, it does not mean the power has been disconnected.**

## Cautions:

- The machine power wiring must be in accordance with national wiring rules, and power line should be connected to the reliable external Earth Line.
- The fixed wiring of the machine connection must be equipped with an all-pole disconnect device (air switch) with at least 0.118-inch distance of electric shock.
- Model specification of the fuse: 5A.
- The distance between the machine and the surrounding objects: at least 1 meter.
- This appliance is intended for indoor, residential applications only. Do not use this dehumidifier outdoors.
- Factory inspection may lead to residual water stain in the reservoir, which is a normal phenomenon.
- The power cord must be plugged into an outlet that is properly grounded. To reduce the risk of fire, electric shock, injury or sickness when using your dehumidifier, follow these basic precautions:

Plug into a grounded 3 prong outlet.

Do not remove any prong from the power cord.

Do not use an extension cord or an adaptor plug.

Do not splice the power cord.

Unplug dehumidifier before servicing.

If the power supply cord is damaged, it must be replaced by the manufacturer, its service agent or similar qualified person in order to avoid hazard.

# SAFETY INSTRUCTIONS

- Children should be supervised to ensure that they do not play with the appliance.
- This appliance is not intended for use by persons (including children) with reduced physical, sensory or mental capabilities, or lack of experience and knowledge, unless they have been given supervision or instruction concerning use of the appliance by a person responsible for their safety.

## Position

1. This unit may have been tilted or placed upside down during shipping. To ensure this device works properly, please make sure it is upright for at least 24 hours before the initial use.
2. If excessive moisture is diffused in the space, the dehumidifier should be placed in the center of the space, so as to dehumidify the space evenly and effectively.
3. If the moisture in a certain area of the space is particularly high, you can place the dehumidifier directly in this area at first before you move it to the center position.
4. In order to achieve the best dehumidification effect, the external doors and windows should be closed when the dehumidifier is in operation. Do not place this product near or directly next to a heater or other heat source.
5. When placing the dehumidifier, be sure to place it on a level surface. And there should be no objects obstructing the air flow in the air inlet and outlet.
6. Before moving the product, turn off the power and drain out the water. When moving, the machine body should not be tilted more than 45 degrees.

## Storing The Dehumidifier

When you want to store the dehumidifier because you don't use it for a long time. Please pay attention to the following steps:

1. Empty the water in the water tank.
2. Roll up the power cord and tie it up.
3. Clean the filter.
4. Place the machine in a cool and dry environment.

PARTS  
DESCRIPTION

Parts Description

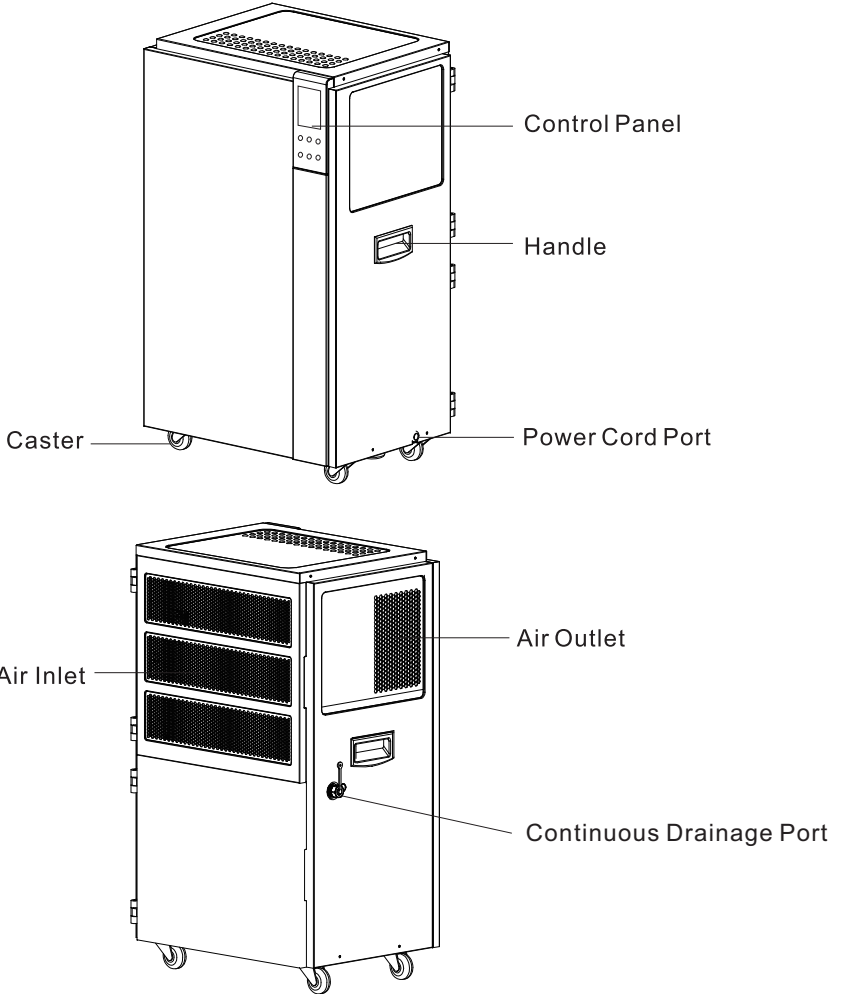



Schematic Diagram

Note: This picture shows the dehumidifier Outline Drawing. Other models may vary a little from shape and size, please prevail in kind.



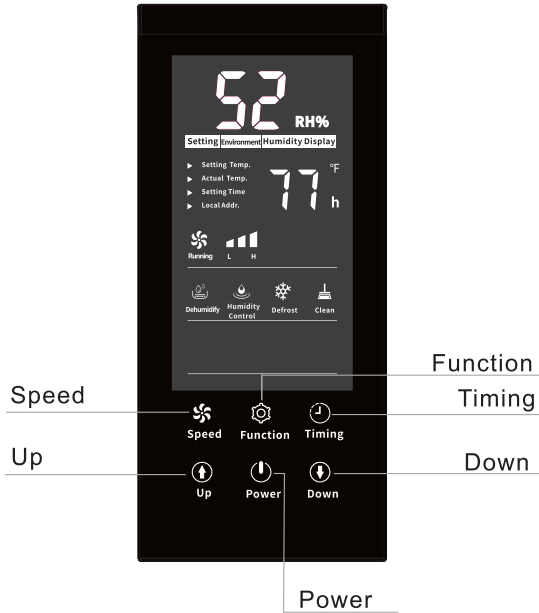

## Control Panel





	Used to power on or power off the machine.
--	--

	Used to set the humidity and timing value down
--	--

	Used for setting the time
--	---------------------------

	Used to set the humidity and timing value up
---	--

	Press to confirm the parameters setting.
---	--

	Used to switch to high and low wind speed
---	---

## Operation

### Humidity Setting

In power-on status, press "Up" or "Down" button to enter the humidity setting status:

The screen will display the "Setting" and "Humidity Display" icon, the unit icon "RH%" will light up, and the large figure "52" will flash to show the humidity value.

In humidity setting status, you can press the "Up" or "Down" button to set the desired humidity within the range of 10-98RH%.

If you press the "function" button or no operation after seconds, you will exit the humidity setting status automatically.

When the setting humidity is 10RH%, the machine will be forced to run at continuous working mode.

### Timer Setting

In power-on status, press the "Timing" button, you will enter the Timer setting mode:

The "▶" will point at "Setting Time" function, the time unit "h" will light up and the small figure "77" will flash to show the setting value.

In Timer setting status, press "Up" or "Down", you can set a time within the range of 1 to 24 hours, which can be set again if invalid.

If you press the "function" button or no operation after seconds, you will exit the humidity setting status automatically.

If the time it's set to be "00", this is called the invalid time.

### Speed Setting

Two wind speed modes are available for this machine, you can press the "Speed" button to switch to high or low wind speed.

### Parameter Query

In power-on status, press the "Function" button once, you will enter the parameter query status.

The "▶" will point at "Setting Temp.", the small figure will display the setting temperature and the temperature unit "°F" will light up. Press the "function" button again, you will be able to query the ambient temperature and setting time.



### Status Description

When the fan is delayed, the running symbol "🌀" will flash, and if the fan is running, the running symbol "🌀" will be on, otherwise it will be off.

When the compressor is delayed, the dehumidification symbol "💧" will flash, and if the compressor is running, the dehumidification symbol "💧" will be on, otherwise it will be off.

# OPERATION INSTRUCTIONS

If the ambient humidity is lower than the setting humidity and the compressor is stopped, the Humidity Control Symbol "  " will flash, otherwise it will be off.

When the fan speed is set to high level, the symbol "  " will light up; when the fan speed is set to low level, the symbol "  " will light up.

When the machine needs to be cleaned, the cleaning symbol "  " will flash, otherwise it is off.

When the machine is defrosting, the defrost symbol "  " will flash, and goes out after finishing the defrosting process.

## Power off Memory Function

After the device is powered on, it will automatically resume the working status before power off.

- If the machine's running before power outage, the machine will automatically enter power-on status, and maintain the previous setting parameters.
- If the machine's shut down before the power outage, then the machine will still be in power-off status.

## Defrost Function

When the dehumidifier is running at a lower temperature, the system will automatically determine whether there is a presence of frost. If any frost exists, it will defrost automatically.

The fan will run at high wind speed and the compressor stops when defrosting, and switch back to the previous setting wind speed after that. The compressor can be restarted then.

## Temperature Protection Function

When the ambient temperature is higher than the Default Highest Temperature (113°F), the system will enter high temperature protection, the small figure on the screen will indicate "HH", and the compressor will stop.

When the ambient temperature is lower than the Default Lowest Temperature (39 °F), the system will enter the low temperature protection, the small figure on the screen will indicate "LL", and the whole machine will stop.

## Cleaning Reminder

If the accumulative running time of the fan is  $\geq 30$  days, the machine can continue to run, but it will keep prompting the "Cleaning" icon and it will not be able to be removed even re-powered.

In power-off status, long press the "Speed" button for seconds, then the display screen will show up for once, which means the "Clean" prompt has been released, and the fan's previous running time has been cleared.

## Special Note:

The compressor features a "3 minutes delay protection" function—While the dehumidifier is powered, the compressor can only start again 3 minutes after its last shutdown.

# ERRORS AND PROTECTION CODE

## Faults & Protection Codes:

Number	Error Code	Name of the Fault
1	E1	Humidity sensor error
2	E2	Defrost Temperature sensor error
4	E4	Ambient temperature sensor error
5	E5	System high voltage failure
6	E6	System low voltage failure
7	Ec	Display board is abnormal

### Note:

1. When E1, E2 or E4 fault occurs, the compressor and fan will not stop.
2. If the display screen reads the error code of "E5" or "E6", please turn off, unplug the unit, and check for obstructions. Plug it in again and restart the dehumidifier.
3. When Ec occurs, the machine will not be controlled by the control panel.
4. During the fault alarm, press any key to cancel the alarm sound. If the Error Code is still present, please don't hesitate to contact Waykar Customer Service email at [support@waykar.com](mailto:support@waykar.com) for help.

# PRODUCT SPECIFICATIONS

## Product Specifications

MODEL	PD1201B
POWER SOURCE	120V~60Hz
RATED POWER (95°F, 80%)	1900W
RATED CURRENT (95°F, 80%RH)	17A
RATED POWER (80°F, 67°F)	1200W
RATED CURRENT (80°F, 67°F)	10.5A
MOISTURE REMOVAL CAPACITY (65°F, 60%RH)	94 Pints/Day (44.4L/Day)
MOISTURE REMOVAL ( 80°F, 60%RH)	143 Pints/Day (68L/Day)
MOISTURE REMOVAL (86°F, 80%RH)	243 Pints/Day (115L/Day)
MOISTURE REMOVAL (95°F, 80%)	296 Pints/Day (140L/Day)
INPUT POWER (65°F, 60%RH)	1000W
INPUT CURRENT (65°F, 60%RH)	9.0A
MOTOR FLA	1.3A
MOTOR COMPRESSOR	RLA:11.8A LRA:53.0A
REFRIGERANT	R410A/37ozs(1050g)
MAXIMUM ALLOWABLE PRESSURE	800PSIG(5.5MPa)
HIGH PRESSURE	580PSIG(4.0MPa)
LOW PRESSURE	247PSIG(1.7MPa)

The machine should be operated under the temperature range of 41-100 °F, if the room temperature exceeds this range, the product may not work properly.

Waykar reserves the right to change the product, the above parameters are subject to change without prior notice.

# SAFETY NOTE AND MAINTENANCE METHODS

## Safety Note and Maintenance Methods

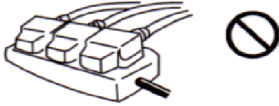

Do not use overall relay, extension cable or adapter to connect this device. Wrong application could cause fire, electric shock or heating.

Do not place this device close to furnace, heater and devices that could produce heat. Wrong application could cause resin melt and even fire.

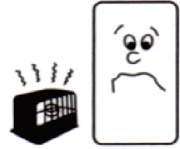

Do not use the machine in the area that is subject to direct sunlight, wind or rain, indoor application only.

Turn off the machine and remove the power wire when problem happens (e.g. the machine emits a smell of burning.).



Wrong application could result in fire, electric shock and new failure.



Do not use the machine in the area that could be affected by chemical. The medicine or solvent permeated into air could cause bad influence to the device and cause leakage of water in the tank.



Remove the power cable when do not use the machine for a long time.



Turn off the machine and remove the power cable when cleaning the machine. Improper operation could cause personal injury.

Place the drainage hose well when drain water continuously so as to flow the water freely. If work in a cold temperature that could freeze the water, then the continuous drainage may not be applicable.

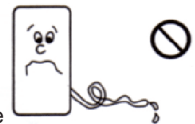

# SAFETY NOTE AND MAINTENANCE METHODS



Do not repair, disassemble or modify this machine through do-it-yourself. Wrong application could cause fire or accident of electric shock.

Place this machine on a stable site or platform. If the device is tip over, the water inside could leak, which damages the surrounding items and cause electric leakage, fire or electric shock.



The way to extend the application life of air purification filter screen is to place the filter into a plastic bag, before you seal and store when do not use the device for a long time.

Do not use the machine in the area that is adjacent to water, as electric leakage could happen when this machine encounters water and will cause fire or electric shock.



Please apply proper power switch, wrong application could cause fire or electric shock.



Do not damage or alter power cable. Please do not place heavy item on the power cable, heat or drag the power cable with force, or it could damage the power cable and cause fire or electric shock.



Please connect the power cable with the switch securely. Looseness of power cable could pose a safety risk of electric shock.



Do not pull the power cable to stop the operation of the machine. Wrong application could cause fire or electric shock.

## Cleaning and Maintenance

- Turn off the machine and pull out the plug before maintaining and cleaning the product.
- Clean the dehumidifier body with a soft damp cloth.
- Do not use detergent, steel wool, chemically treated cloth, benzine, benzene, thinner or other solvents to clean and wipe the machine.

### **Clean the filter**

- This dehumidifier has a washable filter that blocks most of the airborne dirt such as dust, smoke, animal dander, mold spores and pollen.
- It is recommended to check the filter regularly and clean it at least once a month.

### **Take out the filter**

- Use a vacuum cleaner to gently remove dirt from the filter.
- If the washable filter is particularly dirty, rinse it with warm water and a mild detergent, and air dry it thoroughly. Do not let the sun shine directly or dry the filter with other exothermic products, this will deform the filter and its frame.
- Put the filter back into the machine.

This dehumidifier dehumidifies through continuous drainage. Please follow the below instructions to set up the drainage method.

1. The machine is shipped with a drainage hose, please attach it to the continuous drainage port before use.
2. Ensure that the drainage hose is not bent or knotted during use and can drain smoothly. If any fault occurs, please follow the "Common Troubleshooting" in the manual before notifying the After-sales Service.

Do not repair or disassemble the dehumidifier yourself. Improper maintenance may endanger the safety of the user.



# COMMON TROUBLESHOOTING

## Common Troubleshooting

PROBLEM	CAUSE	SOLUTION
Dehumidifier does not operate.	<ol style="list-style-type: none"><li>1. Power failure.</li><li>2. The power switch is not connected.</li><li>3. The power plug is not plugged into the socket.</li><li>4. The fuse has blown out.</li><li>5. Machine failure prompt.</li></ol>	<ol style="list-style-type: none"><li>1. Restore power.</li><li>2. Turn on the switch</li><li>3. Plug in the socket.</li><li>4. Replace the fuse.</li><li>5. Check the error code, ask seller for help.</li></ol>
Dehumidifier operating, but room not dry.	<ol style="list-style-type: none"><li>1. There is too much dust in the filter.</li><li>2. The air inlet and outlet are obstructed.</li><li>3. All doors, windows and other openings are open.</li><li>4. Refrigerant leak.</li></ol>	<ol style="list-style-type: none"><li>1. Clean the filter.</li><li>2. Remove obstacles.</li><li>3. Close the door and windows.</li><li>4. Ask seller for help.</li></ol>
Water reservoir leaking.	<ol style="list-style-type: none"><li>1. The Machine is tilted</li><li>2. Clogging of water drainage port.</li></ol>	<ol style="list-style-type: none"><li>1. Adjust the machine to a horizontal position.</li><li>2. Remove the panel to clean the dirt inside the port.</li></ol>
The dehumidifier makes a loud noise when operating.	<ol style="list-style-type: none"><li>1. The machine is tilted, instead of upright as it should be.</li><li>2. The air filter is clogged.</li></ol>	<ol style="list-style-type: none"><li>1. Place the machine levelly.</li><li>2. Clean the filter.</li></ol>

1. When the above faults can not be ruled out, confirmed and repair is needed, please contact the seller at [support@waykar.com](mailto:support@waykar.com), do NOT disassemble the machine for repair without permission.

2. When the dehumidifier is running or stopped, the refrigerant circulation sound will be heard, which is normal.

3. It is normal for hot air to be discharged from the air outlet.

## Warranty

---

Waykar offers a 12-month warranty to all of our products together with the original proof of purchase when a defect occurred, including those newly purchased and unused, from Waykar or through an authorized reseller, wholly or substantially, or as a result of faulty manufacturing parts, or workmanship during the Warranty Period. The warranty does not apply if damage is caused by other factors, including but without limitation of:

- (a) Normal wear and tear;
- (b) Abuse, mishandling, accident or failure to follow operating instructions;
- (c) Exposure to liquid or infiltration of foreign particles;
- (d) Servicing or modification of the product other than by Waykar.

There are our general terms for the warranty service, but we always encourage our customers to contact us if any issues, regardless of warranty terms. If you are experiencing an issue with Waykar product, you can reach out to us at [support@waykar.com](mailto:support@waykar.com), we will dedicate our efforts to resolve it for you.

## Extend Your Warranty by 1 Year

---

Register your product at [www.waykar.com](http://www.waykar.com) to extend your 1-year warranty by an additional year.

\*Please fill out all required fields and include your Order ID, Date of Purchased if applicable.

## Customer Support

---

If you have any questions or concerns about your product, please feel free to contact our expert support team. Waykar customer service is here to help.

### **Waykar Office**

13211, Spring Street Baldwin Park, CA, US

Email: [support@waykar.com](mailto:support@waykar.com)

Live Chat: [www.waykar.com](http://www.waykar.com)

### **Support Hours**

24 Hours available

\*Please have your Order Number ready before contacting customer support.



# waykar

For FAQs and more information please visit:

[www.waykar.com](http://www.waykar.com)



@Waykar



@Waykar



@Waykar



@Waykar



(Scan the QR Code for Live Chat)

We are expecting to see our products fulfill your life and hear your voice.

Your satisfaction means a lot to us.

Please tag us if you share a snap on your social media.

[www.waykar.com](http://www.waykar.com)