

# Instruction Manual

*Wireless Backup Camera System  
7" Quad View Display with Built-in DVR*

RVS-4CAM



Please read this manual before using the product.  
It may be different from how it is described in the manual  
depending on the software version.

## ***In The Box for Standard RVS-4CAM***

- 1 x Color CCD Infra-Red Weatherproof Wireless Backup Camera
- 1 x 7" Quad View Monitor with Built-In DVR and Sunshade
- 1 x Universal Mount With Adhesive Pad
- 3 x Wireless Antennas
- 1 x Camera Power Cable
- 1 x Screw Kit for Camera Installation

## ***TABLE OF CONTENTS***

Package Contents / Table of Contents . . . . .	<b>2</b>
Introduction. . . . .	<b>3</b>
Safety Information. . . . .	<b>4 - 6</b>
Before Beginning Installation . . . . .	<b>7</b>
Precautions. . . . .	<b>8</b>
Install Guide . . . . .	<b>9 - 10</b>
System Operations. . . . .	<b>11</b>
Pairing. . . . .	<b>12</b>
Recording. . . . .	<b>13</b>
User Interface . . . . .	<b>14 - 17</b>
Monitor Specifications . . . . .	<b>18</b>
Camera Specifications . . . . .	<b>19</b>
Monitor & Camera Placement . . . . .	<b>20</b>
Warranty. . . . .	<b>21</b>
Disclaimer. . . . .	<b>22</b>
Notes. . . . .	<b>23</b>

**NOTE!**

***Please read all of the installation instructions carefully before installing the product. Improper installation will void manufacturer's warranty.***

***Congratulations*** on purchasing a Rear View Backup Camera System!

With this manual you will be able to properly install and operate the unit.

The Backup Camera System is intended to be installed as a supplement aid to your standard rear view mirror that already exists in your vehicle. The Backup Camera System should not be used as a substitute for the standard rear view mirror or for any other mirror that exists in your vehicle.

In some jurisdictions, it is unlawful for a person to drive a motor vehicle equipped with a TV viewer or screen located forward of the back of the driver's seat or in any location that is visible, directly or indirectly, to the driver while operating the vehicle.

Please read the entire manual and follow the instructions and warnings carefully. Failure to do so can cause serious damage and/or injury, including loss of life. Be sure to obey all applicable local traffic and motor vehicle regulations as it pertains to this product. Improper installation will void manufacturer's warranty.

## **USAGE:**

- The Rear View Camera System is designed to help the driver safely detect people and/or objects helping to avoid damage or injury. However, you the driver, must use it properly. Use of this system is not a substitute for safe, proper or legal driving.
- Never back up while looking at the monitor alone. You should always check behind and around the vehicle when backing up, in the same way as you would if the vehicle did not have the Rear View Camera System. If you back up while looking only at the monitor, you may cause damage or injury. Always back up slowly.
- The Rear View Camera System is not intended for use during extensive back-up maneuvers or backing into cross traffic or pedestrian walkways.
- Please, always remember, the area displayed by the Rear View Camera System is limited. It does not display the entire panorama that is behind you.

## **INSTALLATION:**

- Electric shock or product malfunction may occur if this product is installed incorrectly.
- Use this product within the voltage range specified. Failure to do so can cause electronic shock or product malfunction.
- Take special care when cleaning the monitor.
- Make sure to firmly affix the product before use.
- If smoke or a burning smell is detected, disconnect the system immediately.
- Where the power cable may touch a metal case, cover the cable with friction tape. A short circuit or disconnected wire may cause a fire.
- While installing the Rear View System be careful with the wire positioning in order to avoid wire damage.
- The Rear View System should only be used when the vehicle is in reverse.
- Do not watch movies or operate the monitor while driving; as it may cause an accident.
- Do not install the monitor where it may obstruct drivers view or obstruct an air bag device.
- Dropping the unit may cause possible mechanical failure.

*If you have questions about this product, contact:*

***Rear View Safety  
1797 Atlantic Avenue  
Brooklyn, NY 11233  
Tel: 1.800.764.1028***

IN NO EVENT SHALL SELLER OR MANUFACTURER BE LIABLE FOR ANY DIRECT OR CONSEQUENTIAL DAMAGES OF ANY NATURE, OR LOSSES OR EXPENSES RESULTING FROM ANY DEFECTIVE PRODUCT OR THE USE OF ANY PRODUCT.



A Safe Fleet Brand

Before drilling please check that no cable or wiring is on the other side of the wall. Please clamp all wires securely to reduce the possibility of them being damaged while vehicle is in use. Keep all cables away from hot/moving parts and electrical noisy components.

***We recommend doing a benchmark test before installation to insure that all components are working properly.***

Step 1: Choose the monitor and camera locations.

Step 2: Install all cables in vehicle, when necessary a 0.8 (20mm) hole should be drilled for passing camera cable through vehicles walls. Install split grommets where applicable.

Step 3: Once all cables and wiring have been properly routed, perform a system function test by temporarily connecting the system.

### *Operating Precautions*

1. The device may be powered by a 12/24 volt battery or the vehicle's electrical system.
2. Make sure all cables are connected properly. Improper cable connections may damage the monitor. Remove the power cable connections when not using the device.
3. The back-up battery may be recharged when the power is on.
4. When battery is fully charged, recharging will automatically stop.
5. If batteries are not used for a while, it may take longer to charge.

## **Warning!**

1. *This monitor is high voltage. Only professionals should open the monitor's case.*
2. *Do not watch the video while driving unless you are monitoring the rear view camera display.*

### **Special Note**

Occasionally, a few highlights or dark spots may appear on the LCD screen. This doesn't necessarily indicate any monitor defects. Never try to repair this device yourself. If any problems occur, immediately turn the display off and notify our company or an authorized dealer. Any disassembly or modification may lead to damage and will also void the warranty.



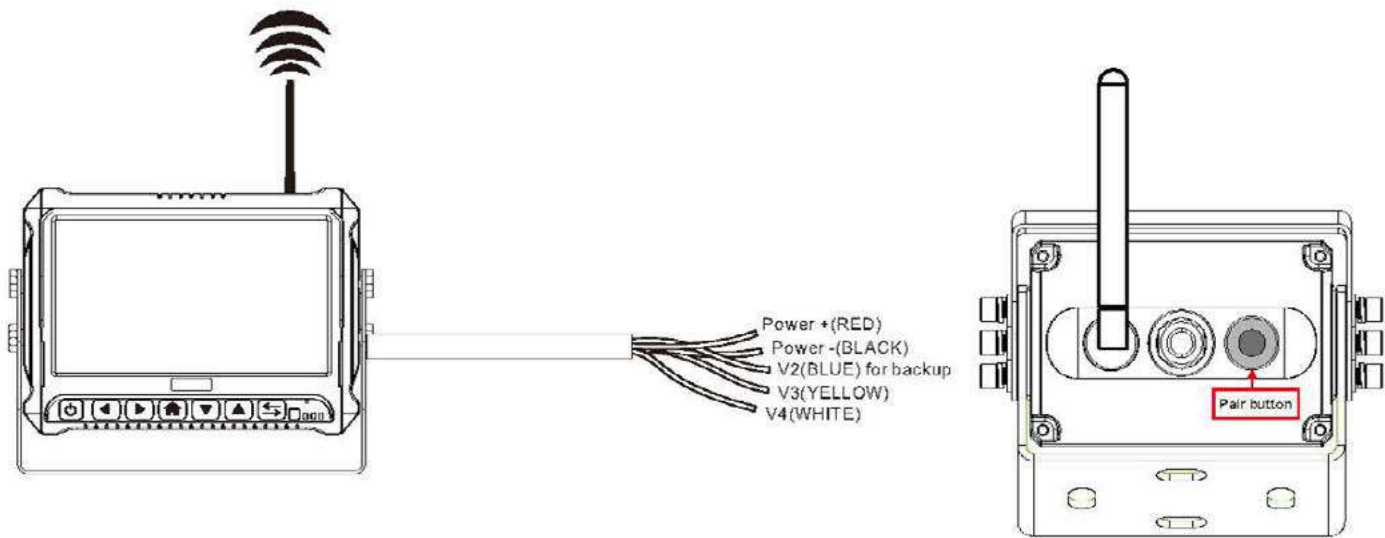

### Camera Connection:

Locate the clearance lights wiring on your vehicle. You may need to remove the interior panel in order to locate. Connect the power cables for camera: **Red** wire to light's positive; **Black** wire to chassis ground.

### Monitor Connection:

Cigarette lighter adapter: firmly insert the lighter plug to the cigarette lighter socket.

**Loose lead wire:** To power the system connect the power (**RED**) 12V + wire to ignition power and the ground (**BLACK**) wire to the chassis ground. These are the only wires needed to power the system. Press power and "arrow" keys to toggle between different views.

Three positive trigger wires (**BLUE-CH2, YELLOW-CH3, WHITE-CH4**) represent a channel and activate when trigger wire connects to 12V.

"CAM2" is the designated backup channel. To have the backup camera display when going in reverse, connect the **BLUE** wire to reverse power (or any power source that comes on only in reverse). The other channels can similarly be triggered (i.e. side cameras can be triggered by the turn signals, etc.)

**DO NOT INSTALL** monitor where it may obstruct driver view or obstruct air bag devices.

## Transmitter for Optional Side Camera

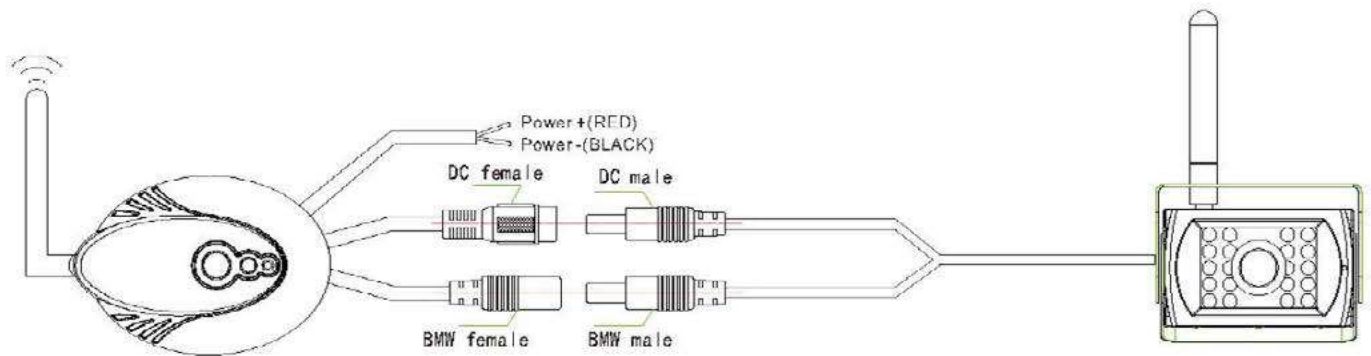

Transmitter for optional side camera

### OPERATION GUIDE

1. The monitor will automatically turn on when connected to a power source. If it is not connected to a camera, it will automatically turn off after 3 seconds.
2. Image will automatically appear on the screen when a trigger is activated.
3. Grid lines can be turned ON/OFF.

### SAFETY NOTICE

This system is designed as a driver's aid.

Just using a backup camera will not completely erase a vehicle's blind spots.

## System Operations

To turn on the monitor, press "POWER ON" button.

To get to Main Menu, press "Home" button use the up and down arrows to navigate the menu and use the "Home" button to confirm your selection.

To go back, press the "REV" (arrows) button. To adjust the volume, use the up and down arrows while viewing the camera

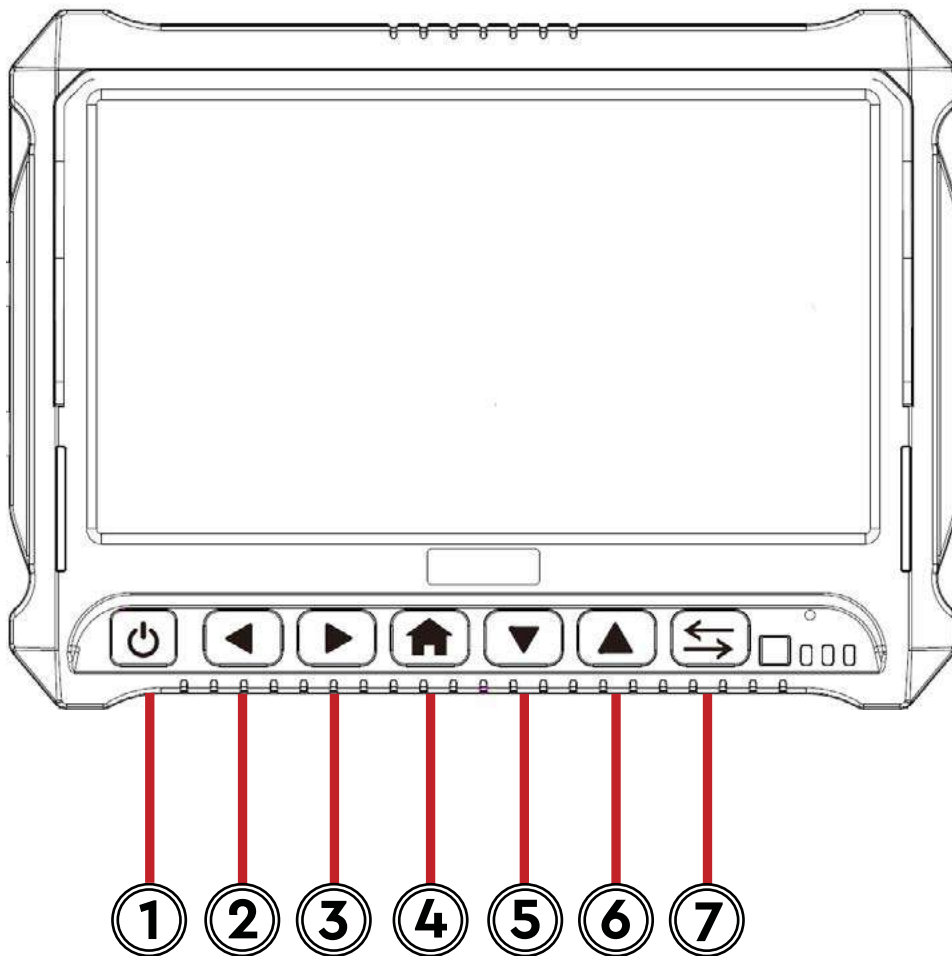

### Menu Buttons

- |         |                 |        |                 |
|---------|-----------------|--------|-----------------|
| ① Power | ③ Right         | ⑤ Down | ⑦ Back / Arrows |
| ② Left  | ④ Menu / Select | ⑥ Up   |                 |

## Pairing

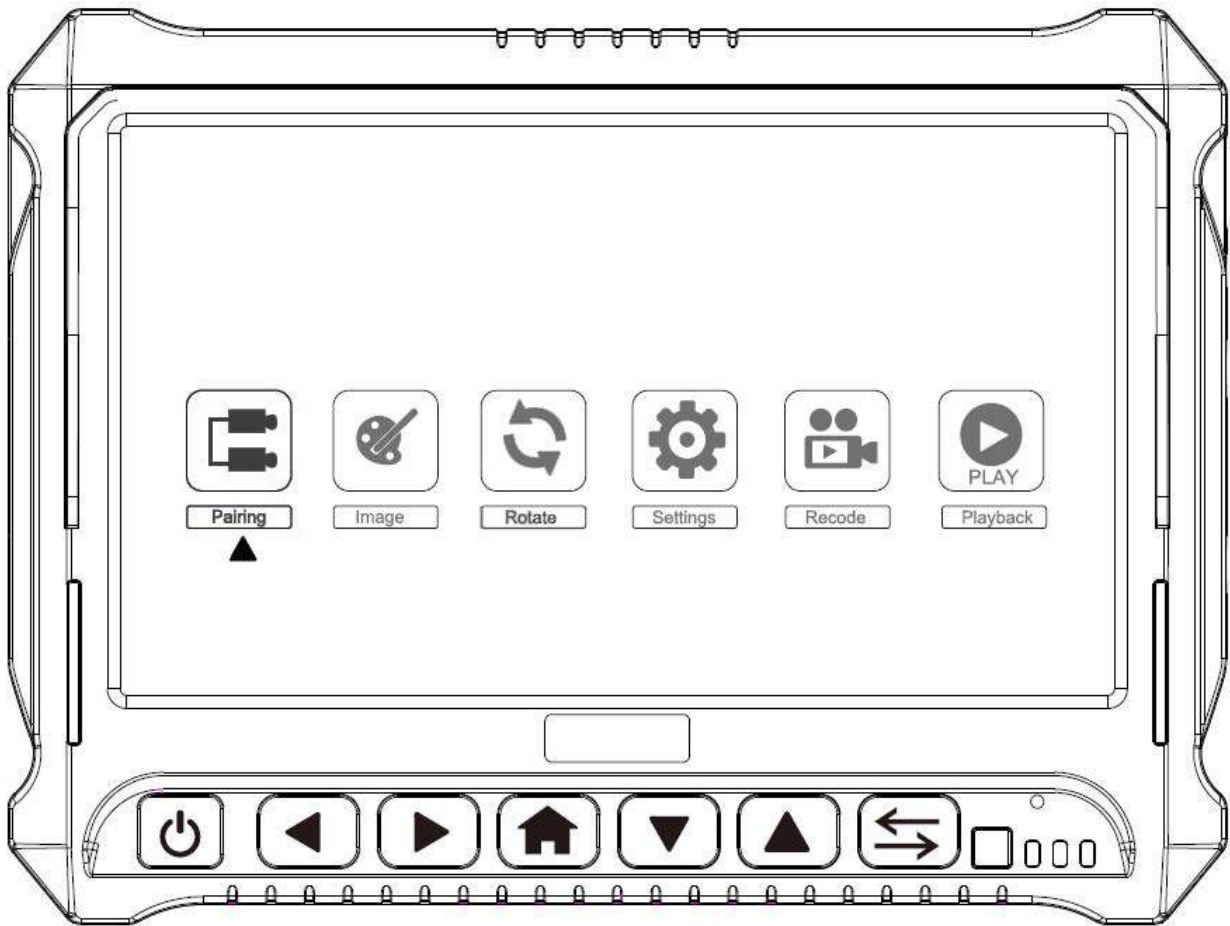

### Pairing:

- 1) Use "right and left" buttons to toggle and select the channel you want to pair.
- 2) Press "Home" to open menu and press "Home" (a second time) to start "pairing mode". System will count from 50 seconds. "Pairing mode" will last approximately 50 seconds.
- 3) Press pair button on back of camera within 50 seconds (step 2) and camera image will appear. The system is paired.

**NOTE:** Make sure camera is receiving power when you pair. **TIP:** If 50 second countdown does not appear, be sure to press the menu button lightly.

## Recording

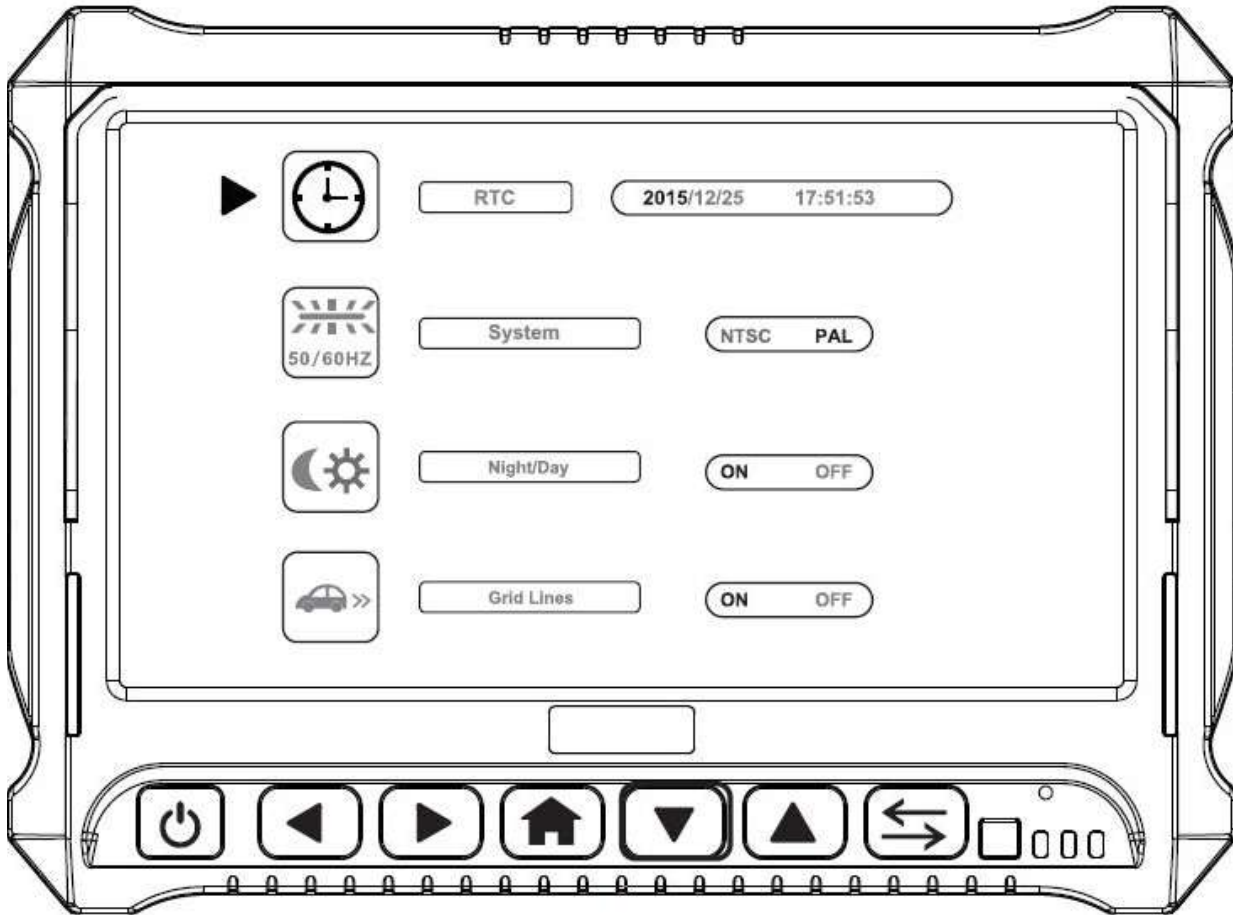

### Recording:

System has capabilities to record all 4 cameras. Start recording:

- 1) Insert a memory card into slot on top of the monitor.
- 2) Format the card by entering the Record option.
- 3) Choose channel to record and turn on.
- 4) When channel and system are active, camera will record.

**Overwrite option** allows system to continuously record while writing (recording) over the oldest footage.

# Image Settings

The image can be modified to the driver's specifications. Easily adjust the Brightness, Contrast, and Color to create the optimal brightness.





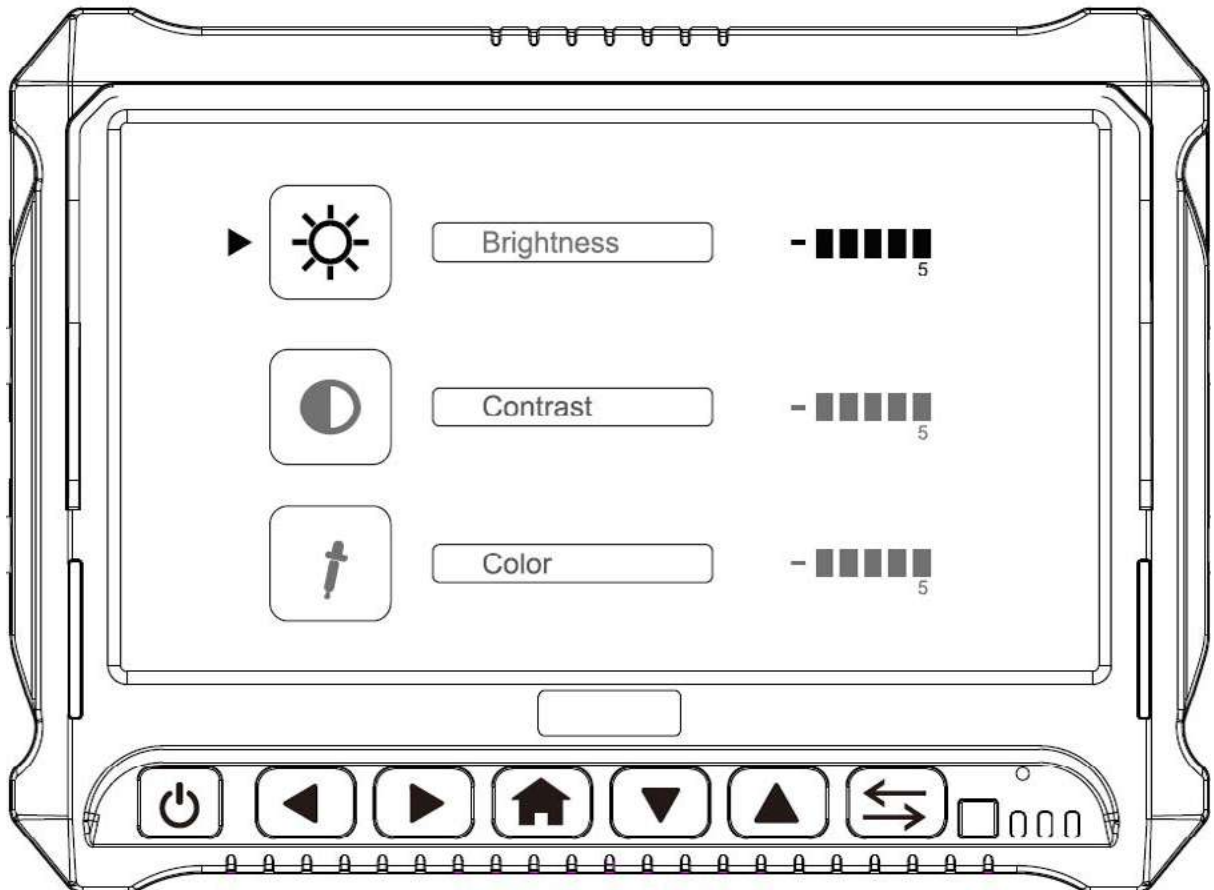

1. Press "  ", Choose "  "  
→ Adjust image
2. Press "  ,  " to adjust.
3. Press "  " to select.

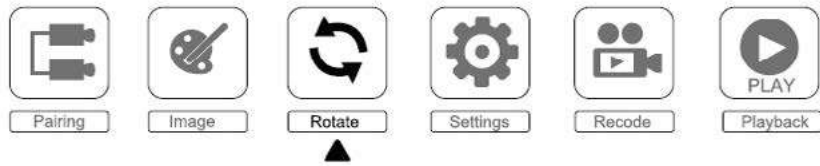

# Screen Rotation Settings



1. Press "  ", Choose "  " → Adjust rotation
2. Press "  ,  " to adjust.
3. Press "  " to select.

## Rotation Options (Vertical + Horizontal)

There are many advantages to rotating a screen vertically or horizontally. Different views include :

- Standard Display** - Display in classic view
- Horizontal Reverse** - Display flipped horizontally
- Vertical Reverse** - Display flipped vertically
- Hand V Reverse** - Display flipped vertically + horizontally



Standard Display



Horizontal Reverse

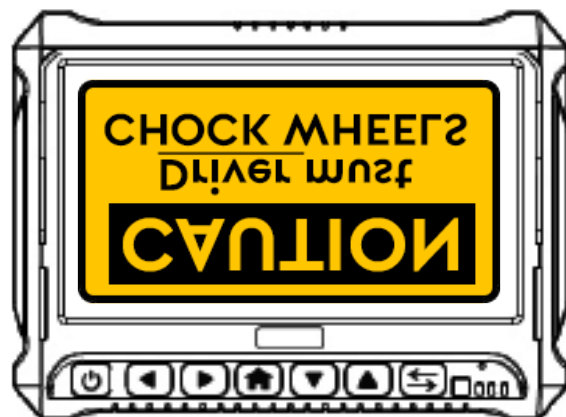







Vertical Reverse

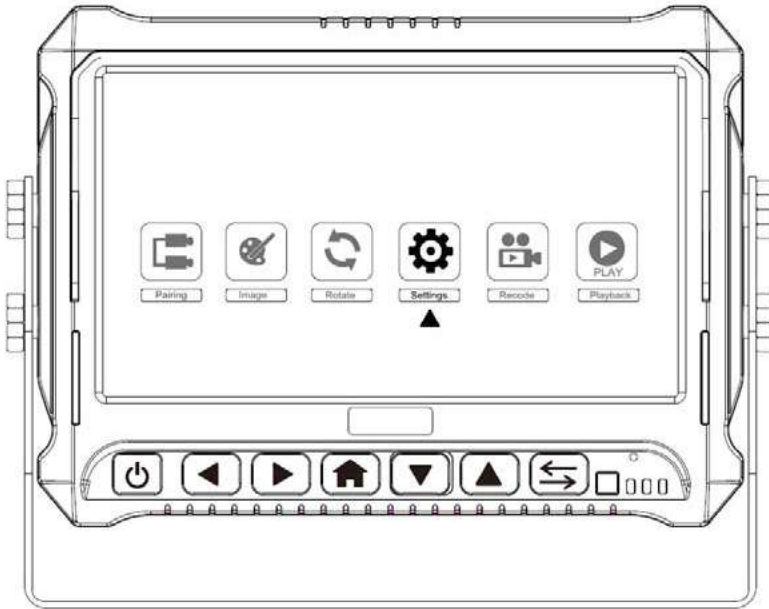

Hand V Reverse

# Settings



- 1. Press "  ", Choose "  " → Adjust settings
- 2. Press "  ",  " to adjust.
- 3. Press "  " to select.

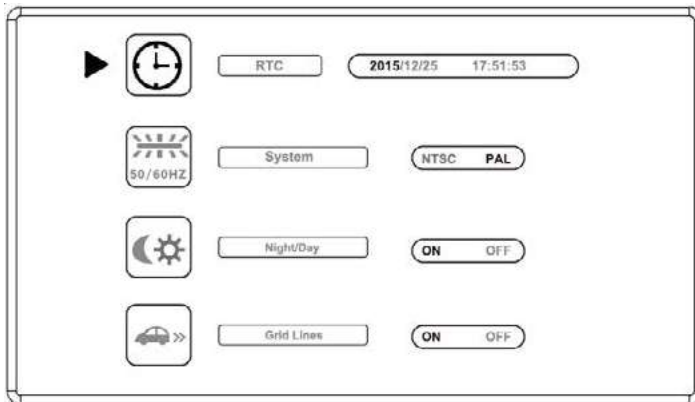

Record Settings

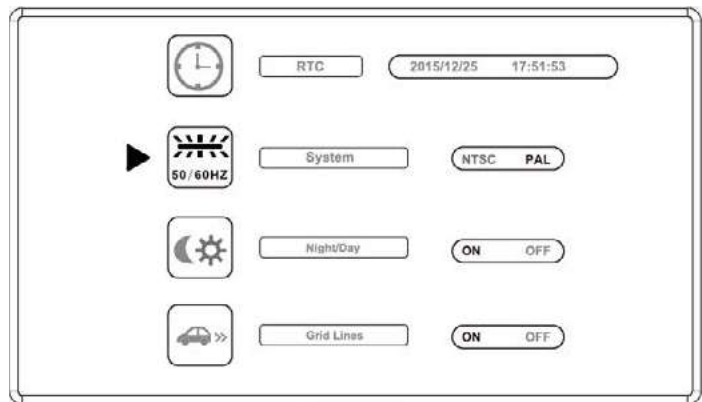

System (NTSC/PAL)

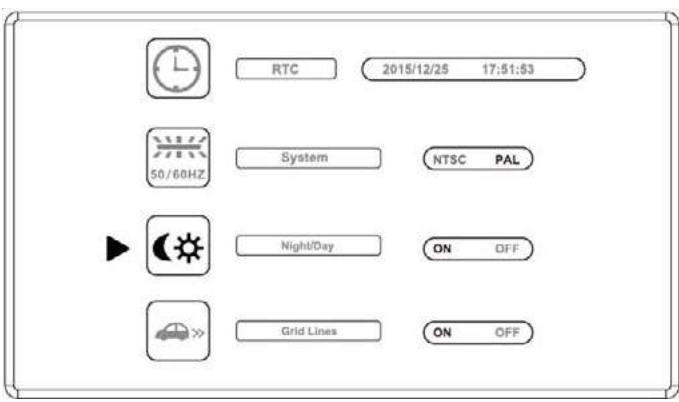

Day / Night Mode

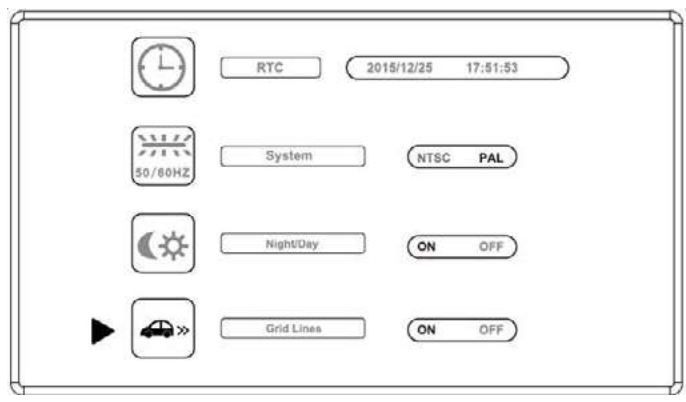

Parking Lines / Grid Lines



## *Playback*

For playback, select the "PLAYBACK" option in the menu and use the "Home" button to select the file you want to play back.

The "Home" button also serves as the pause button.

## *Audio*

CAM2 is the audio enabled channel.

When using a cigarette lighter, audio will be automatically activated.

When using loose lead connections the blue wire must be receiving 12V to activate audio.

## Monitor Specification

- Supports both NTSC and PAL video systems
- Supports 4 cameras with 3 trigger wires. Image automatically switches to respective camera once trigger is activated
- Display effect/volume can be changed for each individual camera
- Multiple Viewing Options – Single/Split Screen/Quad
- Grid lines (can be switched on/off)
- Optional recording function
- 7" digital monitor with touch screen/keys
- Resolution: 800 x 3 RGB x 480
- Contrast: 300:1
- Brightness: 350cd/m<sup>2</sup>
- Input voltage: DC12–24V
- Power consumption: <500mA
- Operating temperature: -20°C ~ 70°C
- Storage temperature: -30°C ~ 80°C



## Camera Specification

Camera Type	1/4" Sharp® Color CCD
Picture Elements	250,000 pixels
Gamma Correction	r=0.45 to 1.0
Viewing Angle	130°
Image Sensor	540 TV lines
PAL Output	752(H)x582(V)
NTSC Output	769(H) x 494(V)
Lens	2.1 mm
Waterproof Rating	IP68
View Angle	130°
Sync System	Internal Synchronization
Infra-red Distance	50 Feet (9 Infrared)
Usable Illumination	0 Lux (IR On)
Power Source	DC 12V/3A (+/- 10%)
S/N Ratio	More than 48dB
Electronic Iris	1/50, 160-1/100,000sec
Video Output	1Vp.p 75Ω
IR Switch Control	ACDS Automatic Control
Vibration and Shock Rating	20G / 100G
Operating Temperature	-30°C ~ +80°C / RH 95% Max
Storage Temperature	-30°C ~ +60°C / RH 95% Max



*Reverse With Confidence™*

Placement

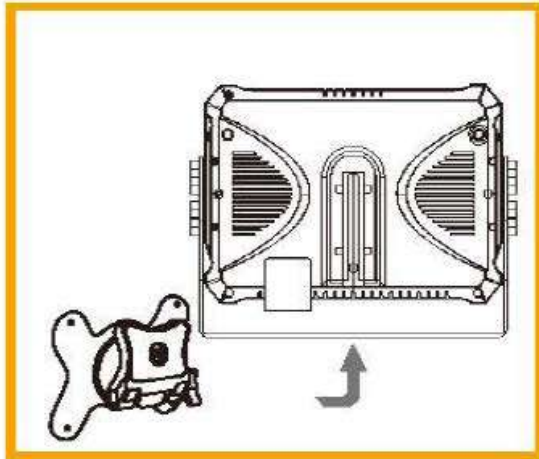

Butterfly / Fans

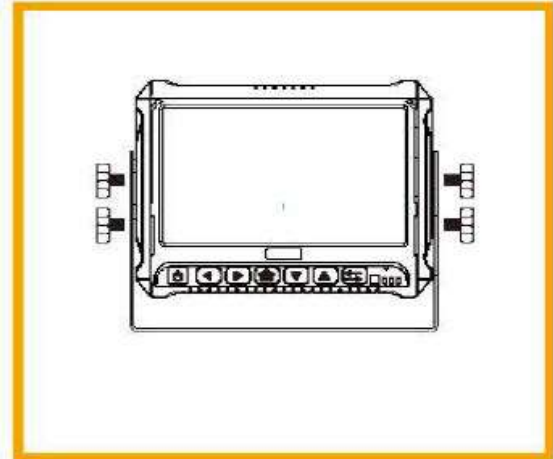

U-Shape

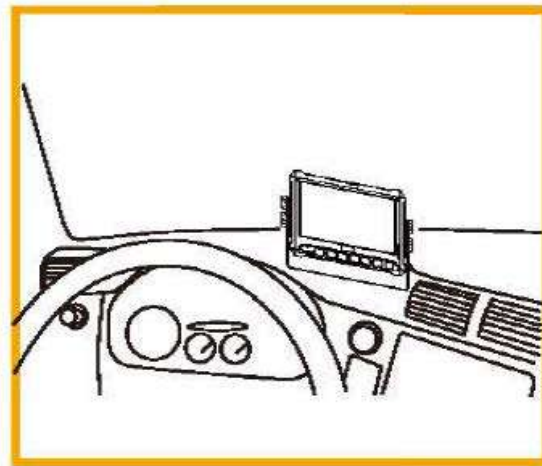

Vertical Stand

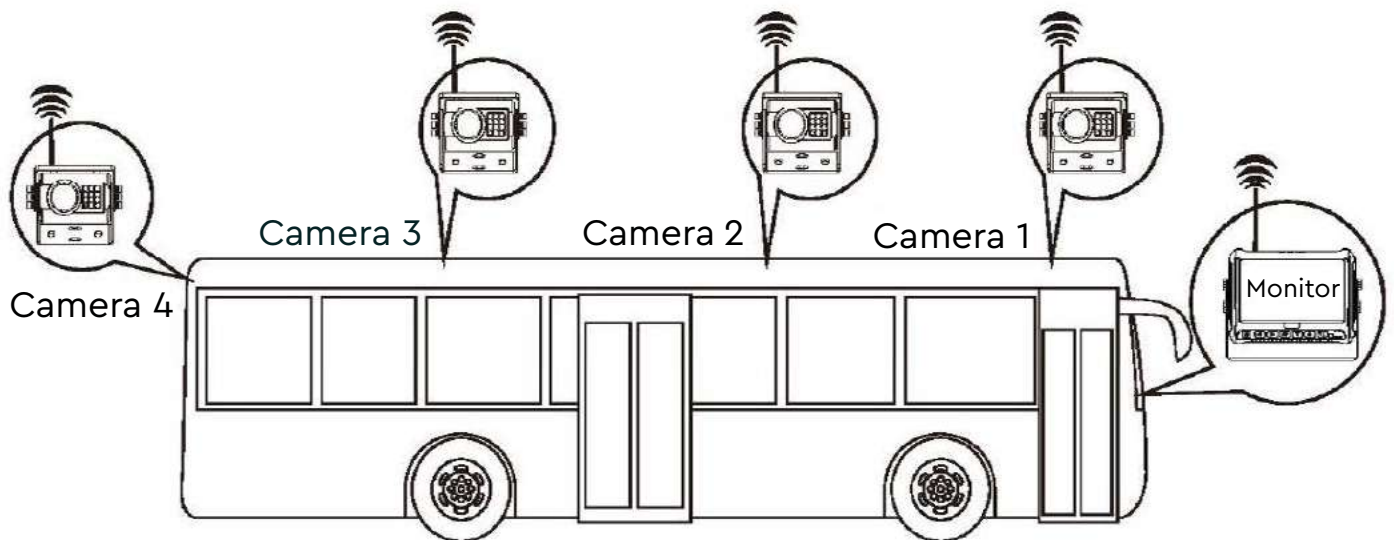

## **ONE YEAR WARRANTY**

REAR VIEW SAFETY , INC. WARRANTS THIS PRODUCT AGAINST MATERIAL DEFECTS FOR A PERIOD OF ONE YEAR FROM DATE OF PURCHASE. WE RESERVE THE RIGHT TO REPAIR OR REPLACE ANY SUCH DEFECTIVE UNIT AT OUR SOLE DISCRETION. REAR VIEW SAFETY , INC. IS NOT RESPONSIBLE FOR A DEFECT IN THE SYSTEM AS A RESULT OF MISUSE, IMPROPER INSTALLATION, DAMAGE OR MISHANDLING OF THE ELECTRONIC COMPONENTS. REAR VIEW SAFETY , INC. IS NOT RESPONSIBLE FOR CONSEQUENTIAL DAMAGES OF ANY KIND.

THIS WARRANTY IS VOID IF: DEFECTS IN MATERIALS OR WORKMANSHIP OR DAMAGES RESULT FROM REPAIRS OR ALTERATIONS WHICH HAVE BEEN MADE OR ATTEMPTED BY OTHERS OR THE UNAUTHORIZED USE OF NONCONFORMING PARTS; THE DAMAGE IS DUE TO NORMAL WEAR AND TEAR, THIS DAMAGE IS DUE TO ABUSE, IMPROPER MAINTENANCE, NEGLIGENCE OR ACCIDENT; OR THE DAMAGE IS DUE TO USE OF THE REAR VIEW SAFETY , INC. SYSTEM AFTER PARTIAL FAILURE OR USE WITH IMPROPER ACCESSORIES.

## **WARRANTY PERFORMANCE**

DURING THE ABOVE WARRANTY PERIOD, SHOULD YOUR REAR VIEW SAFETY PRODUCT EXHIBIT A DEFECT IN MATERIAL OR WORKMANSHIP, SUCH DEFECT WILL BE REPAIRED WHEN THE COMPLETE REAR VIEW SAFETY , INC. PRODUCT IS RETURNED, POSTAGE PREPAID AND INSURED, TO REAR VIEW SAFETY, INC. OTHER THAN THE POSTAGE AND INSURANCE REQUIREMENT, NO CHARGE WILL BE MADE FOR REPAIRS COVERED BY THIS WARRANTY.

## **WARRANTY DISCLAIMERS**

NO WARRANTY, ORAL OR WRITTEN, EXPRESSED OR IMPLIED, OTHER THE ABOVE WARRANTY IS MADE WITH REGARD TO THIS REAR VIEW SAFETY , INC. REAR VIEW SAFETY , INC. DISCLAIMS ANY IMPLIED WARRANTY OR MERCHANTABILITY OR FITNESS FOR A PARTICULAR USE OR PURPOSE AND ALL OTHER WARRANTIES IN NO EVENT SHALL REAR VIEW SAFETY . INC. LIABLE FOR ANY INCIDENTAL, SPECIAL, CONSEQUENTIAL, OR PUNITIVE DAMAGES OR FOR ANY COSTS, ATTORNEY FEES, EXPENSES, LOSSES OR DELAYS ALLEGED TO BE AS A CONSEQUENCE OF ANY DAMAGE TO, FAILURE OF, OR DEFECT IN ANY PRODUCT INCLUDING, BUT NOT LIMITED TO, ANY CLAIMS FOR LOSS OF PROFITS.

## DISCLAIMER

REAR VIEW SAFETY AND/OR ITS AFFILIATES DOES NOT GUARANTEE OR PROMISE THAT THE USER OF OUR SYSTEMS WILL NOT BE IN/PART OF AN ACCIDENT OR OTHERWISE NOT COLLIDE WITH AN OBJECT AND/OR PERSON. OUR SYSTEMS ARE NOT A SUBSTITUTE FOR CAREFUL AND CAUTIOUS DRIVING OR FOR THE CONSISTENT ADHERENCE TO ALL APPLICABLE TRAFFIC LAWS AND MOTOR VEHICLE SAFETY REGULATIONS. THE REAR VIEW SAFETY PRODUCTS ARE NOT A SUBSTITUTE FOR REARVIEW MIRRORS OR FOR ANY OTHER MOTOR VEHICLE EQUIPMENT MANDATED BY LAW. OUR CAMERA SYSTEMS HAVE A LIMITED FIELD OF VISION AND DO NOT PROVIDE A COMPREHENSIVE VIEW OF THE REAR OR SIDE AREA OF THE VEHICLE. ALWAYS MAKE SURE TO LOOK AROUND YOUR VEHICLE AND USE YOUR MIRRORS TO CONFIRM REARWARD CLEARANCE AND THAT YOUR VEHICLE CAN MANEUVER SAFELY. REAR VIEW SAFETY AND/OR ITS AFFILIATES SHALL HAVE NO RESPONSIBILITY OR LIABILITY FOR DAMAGE AND/OR INJURY RESULTING FROM ACCIDENTS OCCURRING WITH VEHICLES HAVING SOME OF REAR VIEW SAFETY PRODUCTS INSTALLED AND REAR VIEW SAFETY AND/OR ITS AFFILIATES, THE MANUFACTURER, DISTRIBUTOR AND SELLER SHALL NOT BE LIABLE FOR ANY INJURY, LOSS OR DAMAGE, INCIDENTAL OR CONSEQUENTIAL, ARISING OUT OF THE USE OR INTENDED USE OF THE PRODUCT. IN NO EVENT SHALL REAR VIEW SAFETY AND/OR ITS AFFILIATES HAVE ANY LIABILITY FOR ANY LOSSES (WHETHER DIRECT OR INDIRECT, IN CONTRACT, TORT OR OTHERWISE) INCURRED IN CONNECTION WITH THE SYSTEMS, INCLUDING BUT NOT LIMITED TO DAMAGED PROPERTY, PERSONAL INJURY AND/OR LOSS OF LIFE. NEITHER SHALL REAR VIEW SAFETY AND/OR ITS AFFILIATES HAVE ANY RESPONSIBILITY FOR ANY DECISION, ACTION OR INACTION TAKEN BY ANY PERSON IN RELIANCE ON REAR VIEW SAFETY SYSTEMS, OR FOR ANY DELAYS, INACCURACIES AND/OR ERRORS IN CONNECTION WITH OUR SYSTEMS FUNCTIONS.

---

---

---

---

---

---

---

---





If you have any questions  
about this product, contact:

***Rear View Safety, Inc.  
1797 Atlantic Avenue  
Brooklyn, NY 11233  
800.764.1028***

***Better Cameras. Better Service.  
IT'S OUR GUARANTEE.***

