



# User Manual

PCE-LCM 50 digital microscope



User manuals in various languages (français, italiano, español, português, nederlands, türk, polski, русский, 中文) can be found by using our product search on: [www.pce-instruments.com](http://www.pce-instruments.com)

Last change: 26 September 2022  
v1.0



## Contents

<b>1</b>	<b>Safety notes</b> .....	<b>1</b>
<b>2</b>	<b>Delivery scope</b> .....	<b>1</b>
<b>3</b>	<b>Specifications</b> .....	<b>2</b>
<b>4</b>	<b>Device description</b> .....	<b>3</b>
<b>5</b>	<b>Lighting</b> .....	<b>3</b>
<b>6</b>	<b>Description of user interfaces</b> .....	<b>4</b>
6.1	Menu screen left:.....	4
6.2	Menu at the bottom .....	11
<b>7</b>	<b>Troubleshooting</b> .....	<b>13</b>
<b>8</b>	<b>Contact</b> .....	<b>13</b>
<b>9</b>	<b>Disposal</b> .....	<b>13</b>

## 1 Safety notes

Please read this manual carefully and completely before you use the device for the first time. The device may only be used by qualified personnel and repaired by PCE Instruments personnel. Damage or injuries caused by non-observance of the manual are excluded from our liability and not covered by our warranty.

- The device must only be used as described in this instruction manual. If used otherwise, this can cause dangerous situations for the user and damage to the meter.
- The instrument may only be used if the environmental conditions (temperature, relative humidity, ...) are within the ranges stated in the technical specifications. Do not expose the device to extreme temperatures, direct sunlight, extreme humidity or moisture.
- Do not expose the device to shocks or strong vibrations.
- The case should only be opened by qualified PCE Instruments personnel.
- Never use the instrument when your hands are wet.
- You must not make any technical changes to the device.
- The appliance should only be cleaned with a damp cloth. Use only pH-neutral cleaner, no abrasives or solvents.
- The device must only be used with accessories from PCE Instruments or equivalent.
- Before each use, inspect the case for visible damage. If any damage is visible, do not use the device.
- Do not use the instrument in explosive atmospheres.
- The measurement range as stated in the specifications must not be exceeded under any circumstances.
- Non-observance of the safety notes can cause damage to the device and injuries to the user.
- Do not touch the lenses.
- When the microscope is not in use, use the dust cover.

We do not assume liability for printing errors or any other mistakes in this manual.

We expressly point to our general guarantee terms which can be found in our general terms of business.

## 2 Delivery scope

- 1 x digital microscope PCE-LCM 50
- 1 x USB mouse
- 1 x micro-SD card
- 1 x protective cover
- 1 x contrast disc black / white
- 1 x translucent lens
- 1 x mains adaptor
- 1 x protective film
- 1 x user manual

### 3 Specifications

Optical lens	1 ... 4 x
Barlow lens	0.3 x
Optical zoom	8.1 ... 32.4 x
Digital zoom	1 ... 10 x
Fixed working distance	90.5 mm
Image sensor	1/3", 3MP
White balance	automatically or by pressing a key
Display resolution	1024 x 600 pixels
Frame rate	30 fps
Pixel size	2.75 x 2.75 $\mu$ m
Signal-to-noise ratio	>65 db
Interface	USB 2.0
Power supply mains adaptor	primary: 100 ... 240 V secondary: 12 V, 1 A
Illumination incident light	ring with 21 x 20 mA LEDs, adjustable in 5 steps
Illumination transmitted light	7 x 20 mA LEDs, adjustable in 5 steps
Environmental conditions	-5 ... 40 °C / 23 ... 104 °F, 45 ... 85 % RH
Dimensions	300 x 225 x 270 mm / 11.8 x 8.9 x 10.6 in
Weight	approx. 2.3 kg / 5.1 lbs

## 4 Device description

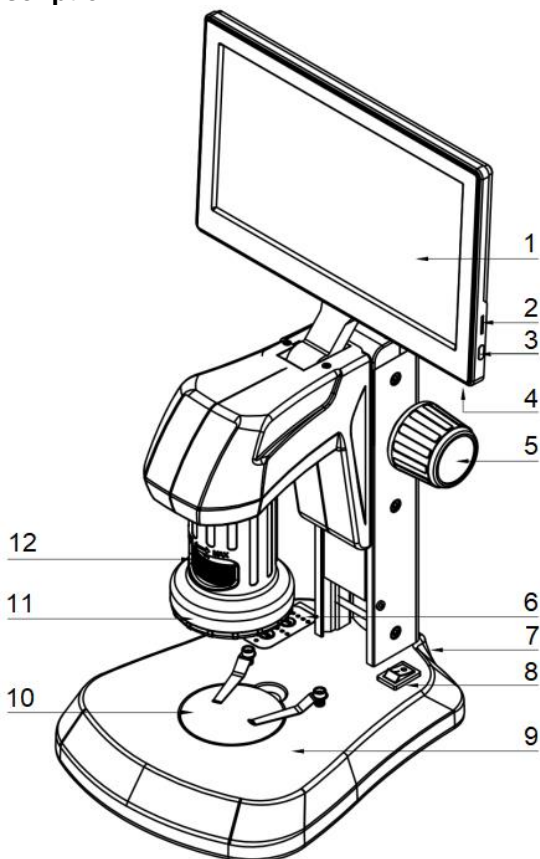

1.	9" display
2.	Micro-SD card slot
3.	On/off switch for the display (standby)
4.	USB 3.0 interface
5.	Focusing wheel
6.	Setting the lighting
7.	Connection for power supply (on the back)
8.	Display on/off switch
9.	Illumination for transmitted light microscopy
10.	Stage
11.	LED ring
12.	Mechanically adjustable zoom

## 5 Lighting

The microscope has an incident and a transmitted light function. The illumination can be adjusted separately in 5 brightness levels. To adjust the illumination, press the "INC" key for incident light and "TRA" for transmitted light. The keys are located on the microscope table.

## 6 Description of user interfaces

The microscope has several user interfaces. These can be opened by moving the mouse to the left or bottom edge of the screen.

### 6.1 Menu screen left:



Click to take a picture. The screen displays a message with the file name.

#### Hint:

Dimension lines and drawing elements are not included in the image.



Click to start and stop a video recording. After the recording has started, a time indication starts in the upper right corner of the display indicating the recording time.



#### File overview

Shows the existing image and video files in a side view.

The navigation through the file overview is explained in chapter 6.1.1.



#### Drawing menu

In the drawing menu, you will find shapes and operations for measuring the image, explained in chapter 6.1.2, and the calibration menu, explained in chapter 6.1.3.



#### Settings menu

Options for the image settings and other system settings such as date and time settings.

### 6.1.1 File overview

The file overview shows images and videos recorded on the SD card. You can switch to the large view of the images with a double click.

Navigation bar:



Back button

Exit the file overview or the large view.



Forward / back button

Navigate through the file overview and the large view.



Delete button

Delete the displayed item.

In the file overview, an entry must be selected by a mouse click.

### 6.1.2 Drawing menu

**Note:** Some characters are placed to indicate distances or areas and are generated based on the stored calibration. The calibration of the PCE-LCM 50 is explained in chapter 6.1.3.



Point

Click to place a point at the current cursor position.



Circle from radius

Select the centre point by a click, then move the cursor to the desired distance for the radius.

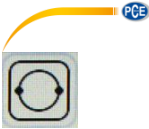

#### Circle from 2 points

Create 2 reference points that lie on the edge of the created circle.



#### Circle from 3 points

Create 3 reference points. The circle is created so that all 3 reference points are on the circumference.



#### Distance between two circles

The function measures a distance between two circles which can be created by various sub-functions.



#### Concentric circles

Create a circle using the circle-from-radius function. Here you can create one or more circles with the same centre point.



#### Distance between line and circle

Create a circle using the circle-from-radius function. Then select 2 points to create a straight line. The measured distance "LD-X" describes the distance between the straight line and the centre of the circle.



#### Polygon

Create a polygon with any number of reference points. To finish the polygon, press the right mouse button.



#### Crosshairs

With one click, you create a reference point with coordinates.



#### Rectangle

Creates a rectangle from 2 reference points.





Line from several points  
Creates a line from several reference points.



Arc from 3 points  
Creates an arc from 3 reference points.



Freehand line  
Creates a line from cursor movements.



Line  
Creates a line from 2 reference points.



Perpendicular lines  
First, a line is created.  
Subsequently, another reference point is used to create a line that is perpendicular to the first line.



Parallel lines  
First, a line is created. Then, with another click, you create the first reference point for the parallel line.  
The start of this is oriented towards the cursor position.  
With another click, you can finish the line.



Angle measurement  
First, a line is created.  
Then create another line from the end point. The smallest angle between the new line and the original line is measured.

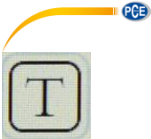

#### Text

A text field is created. After this, a virtual keyboard is displayed to enter a text. Finish the entry by clicking on the "Confirm" button.



#### Sheet export

With this function, you can export the automatically determined dimensions of the drawing elements as a CSV file. This file is saved to the SD card with the corresponding time.



#### Mouse

Switch to the mouse to make further settings.



#### Select and delete

Use the option to select a drawing element on the display to delete it.



#### Delete all

Deletes all drawing elements on the screen.



#### Screenshot

This function saves the image with the created points and graphics to the SD card. These images are not listed in the file overview.

### 6.1.3 Calibration

"Add " Creates a new calibration

"Delete" Deletes the selected calibration

"Edit " Edit the calibration  
Adjusting the name, length and length unit

Place a dimensioned object under the microscope, for example a ruler. Open the drawing menu, click on "Add" in the lower area. Select 2 points to set a distance on the display.

To open the menu again, move the mouse to the left edge of the screen.

Click on "Length" and enter the actual length between the two points. To complete the calibration, click on "Done".

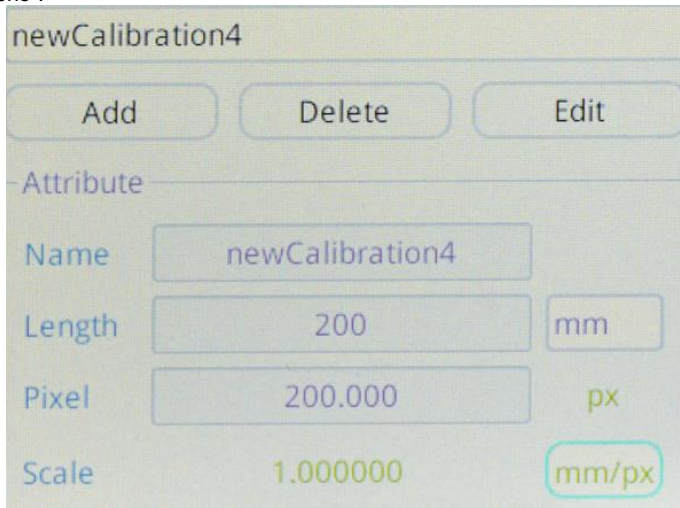

The screenshot shows a calibration settings window titled "newCalibration4". At the top, there are three buttons: "Add", "Delete", and "Edit". Below these is a section labeled "Attribute" containing four rows of settings:

Attribute	Value	Unit
Name	newCalibration4	
Length	200	mm
Pixel	200.000	px
Scale	1.000000	mm/px

Note that a calibration is only valid for a certain focus. If the focus changes, a new calibration is required.

### 6.1.4 Light settings



Automatic exposure

Adjusts the exposure if the resulting image is overexposed or underexposed.

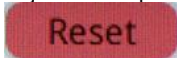

Reset

Resets the light settings.



Target brightness

Setting for automatic exposure.





### Exposure

Controls the light that comes from the LED ring.



### White balance



#### Red

Describes the red / green / blue portion of the image.

Adjustable to perform colour correction.



#### Green



#### Blue

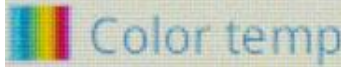

### Colour temperature

Adjusts the red, green and blue portions to create a "cold" or "warm" colour impression.

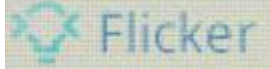

### Antiflicker

Counteracts flickering effects of electric light sources.

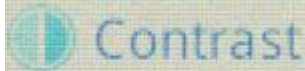

### Contrast

Sets the difference in the brightness of the light and dark parts of the image.



### Saturation

Allows you to create a colourful / achromatic presentation.



### Brightness

Adjustment of the light produced by the LED ring.

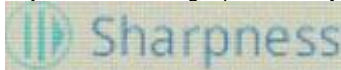

### Sharpness

Controls the difference of details and how much they differentiate from each other.

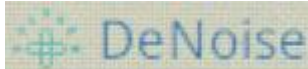

### Noise suppression

Setting to avoid interfering signals in the video transmission.



Language

Available languages: English / German / French / Chinese / Korean



Date setting

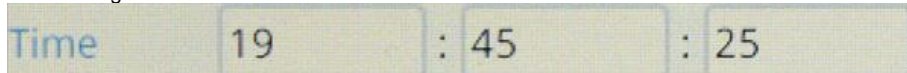

Time setting



Storage option

Selects the storage location for new files and offers the option to format the data media (the included micro-SD card or a USB pen drive).

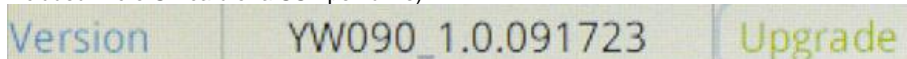

Version

## 6.2 Menu at the bottom



Zoom in

Enlarges the image by a factor of 0.1, up to a maximum of 10.



Zoom out

Reduces the image by a factor of 0.1. The image size cannot become smaller than 1.



Mirror vertical

Mirrors the image on the vertical axis.



Mirror horizontal

Mirrors the image on the horizontal axis.



**Quick saturation**

Corrects the saturation of the settings menu.



**HDR**

Function to compensate for shadows or overexposure.



**Freeze**

Freezes the image.

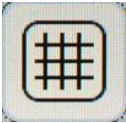

**Grid options**

Settings to show or hide scale bars / a grid.



**Line options**



**Compare to saved image**

Opens the file overview, shows the selected image on the right side of the screen.



**Quarter camera image**

Quarter the current view.

**Attention:**

The calibration is not scaled. You must adjust your calibration if you work with dimensions.

## 7 Troubleshooting

Error	Reason	Solution
The field of vision is dirty	Your sample is contaminated	Clean your sample.
	The lenses are contaminated.	Clean the lenses.
No clear picture	The lenses are contaminated.	Clean the lenses.
Illumination does not work when the supply voltage is connected	No power supply	Check the mains adaptor.
	Lighting defective	Get in touch with PCE Instruments.
Dark image	Brightness setting is too low	Increase the brightness setting.
	White balance is inefficient	Adjust the white balance manually.
	The angle between the display and the microscope is large	Adjust the angle.
No image on the screen	No power supply	Check the mains adaptor and the connection method.
	Screen switch is off	Switch on the display using the display switch.

## 8 Contact

If you have any questions, suggestions or technical problems, please do not hesitate to contact us. You will find the relevant contact information at the end of this user manual.

## 9 Disposal

For the disposal of batteries in the EU, the 2006/66/EC directive of the European Parliament applies. Due to the contained pollutants, batteries must not be disposed of as household waste. They must be given to collection points designed for that purpose.

In order to comply with the EU directive 2012/19/EU we take our devices back. We either re-use them or give them to a recycling company which disposes of the devices in line with law.

For countries outside the EU, batteries and devices should be disposed of in accordance with your local waste regulations.

If you have any questions, please contact PCE Instruments.





## PCE Instruments contact information

### Germany

PCE Deutschland GmbH  
Im Langel 26  
D-59872 Meschede  
Deutschland  
Tel.: +49 (0) 2903 976 99 0  
Fax: +49 (0) 2903 976 99 29  
info@pce-instruments.com  
www.pce-instruments.com/deutsch

### United Kingdom

PCE Instruments UK Ltd  
Unit 11 Southpoint Business Park  
Ensign Way, Southampton  
Hampshire  
United Kingdom, SO31 4RF  
Tel: +44 (0) 2380 98703 0  
Fax: +44 (0) 2380 98703 9  
info@pce-instruments.co.uk  
www.pce-instruments.com/english

### The Netherlands

PCE Brookhuis B.V.  
Institutenweg 15  
7521 PH Enschede  
Nederland  
Telefoon: +31 (0)53 737 01 92  
info@pcebenelux.nl  
www.pce-instruments.com/dutch

### France

PCE Instruments France EURL  
23, rue de Strasbourg  
67250 Soultz-Sous-Forets  
France  
Téléphone: +33 (0) 972 3537 17  
Numéro de fax: +33 (0) 972 3537 18  
info@pce-france.fr  
www.pce-instruments.com/french

### Italy

PCE Italia s.r.l.  
Via Pesciatina 878 / B-Interno 6  
55010 Loc. Gragnano  
Capannori (Lucca)  
Italia  
Telefono: +39 0583 975 114  
Fax: +39 0583 974 824  
info@pce-italia.it  
www.pce-instruments.com/italiano

### United States of America

PCE Americas Inc.  
1201 Jupiter Park Drive, Suite 8  
Jupiter / Palm Beach  
33458 FL  
USA  
Tel: +1 (561) 320-9162  
Fax: +1 (561) 320-9176  
info@pce-americas.com  
www.pce-instruments.com/us

### Spain

PCE Ibérica S.L.  
Calle Mayor, 53  
02500 Tobarra (Albacete)  
España  
Tel. : +34 967 543 548  
Fax: +34 967 543 542  
info@pce-iberica.es  
www.pce-instruments.com/espanol

### Turkey

PCE Teknik Cihazları Ltd.Şti.  
Halkalı Merkez Mah.  
Pehlivan Sok. No.6/C  
34303 Küçükçekmece - İstanbul  
Türkiye  
Tel: 0212 471 11 47  
Faks: 0212 705 53 93  
info@pce-ctihazlari.com.tr  
www.pce-instruments.com/turkish

### Denmark

PCE Instruments Denmark ApS  
Birk Centerpark 40  
7400 Herning  
Denmark